

NUF6406MN

Low Capacitance 6 Line EMI Filter with ESD Protection

This device is a 6 line EMI filter array for wireless applications. Greater than -30 dB attenuation is obtained at frequencies from 800 MHz to 2.4 GHz. It also offers ESD protection—clamping transients from static discharges. ESD protection is provided across all capacitors.

Features

- EMI Filtering and ESD Protection
- Integration of 30 Discrete Components
- Compliance with IEC61000-4-2 (Level 4) > 8.0 kV (Contact)
- DFN Package, 1.35 x 3.0 mm
- Moisture Sensitivity Level 1
- ESD Ratings: Machine Model = C
Human Body Model = 3B
- This is a Pb-Free Device*

Benefits

- Reduces EMI/RFI Emissions on a Data Line
- Integrated Solution Offers Cost and Space Savings in a DFN Package
- Reduces Parasitic Inductances Which Offer a More “Ideal” Low Pass Filter Response
- Integrated Solution Improves System Reliability
- Compatible Footprint to BGA or Flip-Chip Package

Applications

- EMI Filtering and ESD Protection for Data Lines
- Wireless Phones
- PDAs and Handheld Products
- Notebook Computers
- LCD Displays

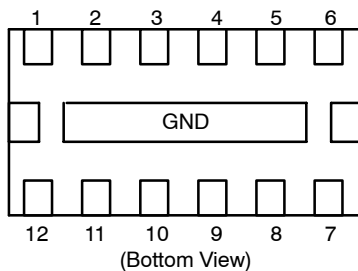

ON Semiconductor®

<http://onsemi.com>

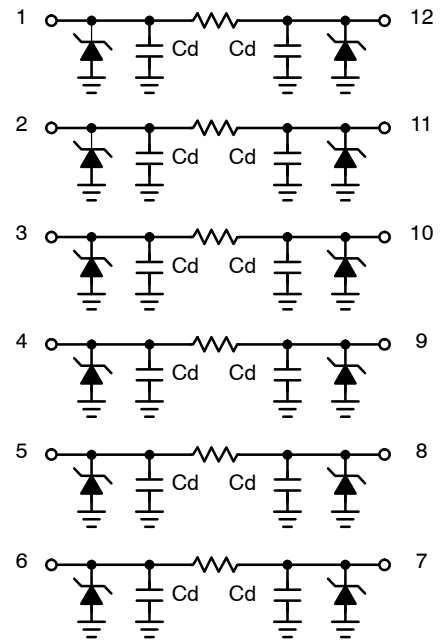

(Top View)

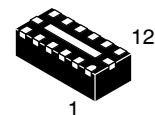

DFN12
CASE 506AD

MARKING DIAGRAM

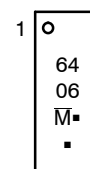

6406 = Specific Device Code
M = Month
▪ = Pb-Free Package
(Note: Microdot may be in either location)

ORDERING INFORMATION

| Device | Package | Shipping† |
|--------------|--------------------|--------------------|
| NUF6406MNT1G | DFN12 (Pb-Free) | 3000 / Tape & Reel |

†For information on tape and reel specifications, including part orientation and tape sizes, please refer to our Tape and Reel Packaging Specifications Brochure, BRD8011/D.

*For additional information on our Pb-Free strategy and soldering details, please download the ON Semiconductor Soldering and Mounting Techniques Reference Manual, SOLDERRM/D.

NUF6406MN

MAXIMUM RATINGS (T_J = 25°C unless otherwise noted)

| Parameter | Symbol | Value | Unit |
|---|------------------|------------|------|
| ESD Discharge IEC61000-4-2 Contact Discharge | V _{PP} | 8.0 | kV |
| Operating Temperature Range | T _{OP} | -40 to 85 | °C |
| Storage Temperature Range | T _{STG} | -55 to 150 | °C |
| Maximum Lead Temperature for Soldering Purposes (1.8 in from case for 10 seconds) | T _L | 260 | °C |

Stresses exceeding Maximum Ratings may damage the device. Maximum Ratings are stress ratings only. Functional operation above the Recommended Operating Conditions is not implied. Extended exposure to stresses above the Recommended Operating Conditions may affect device reliability.

ELECTRICAL CHARACTERISTICS (T_J = 25°C unless otherwise noted)

| Parameter | Symbol | Test Conditions | Min | Typ | Max | Unit |
|---------------------------------|------------------|--|-----|-----|-----|------|
| Maximum Reverse Working Voltage | V _{RWM} | | | | 5.0 | V |
| Breakdown Voltage | V _{BR} | I _R = 1.0 mA | 6.0 | 7.0 | | V |
| Leakage Current | I _R | V _{RWM} = 3.0 V | | | 1.0 | μA |
| Resistance | R _A | I _R = 20 mA | 85 | 100 | 115 | Ω |
| Capacitance (Notes 1 and 2) | C _d | V _R = 2.5 V, f = 1.0 MHz | | 13 | 16 | pF |
| Cut-Off Frequency (Note 3) | f _{3dB} | Above this frequency, appreciable attenuation occurs | | 138 | | MHz |

1. Measured at 25°C, V_R = 2.5 V, f = 1.0 MHz.
2. Total line capacitance is 2 times the Diode Capacitance (C_d).
3. 50 Ω source and 50 Ω load termination.

NUF6406MN

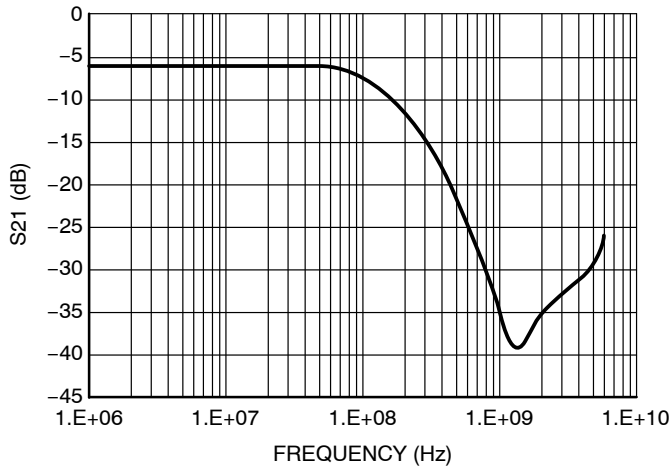

Figure 1. Insertion Loss Characteristic

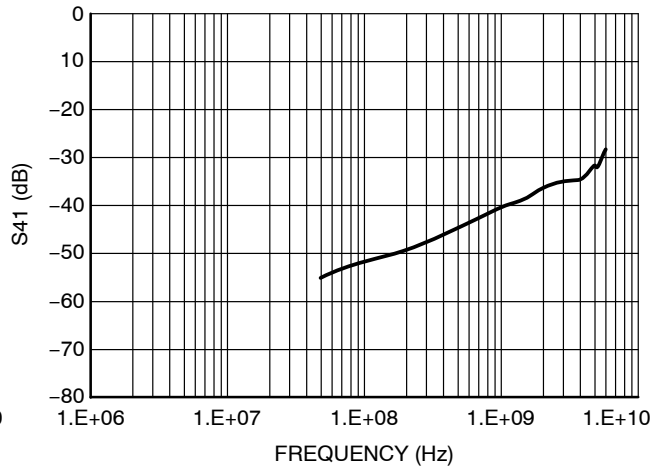

Figure 2. Analog Crosstalk

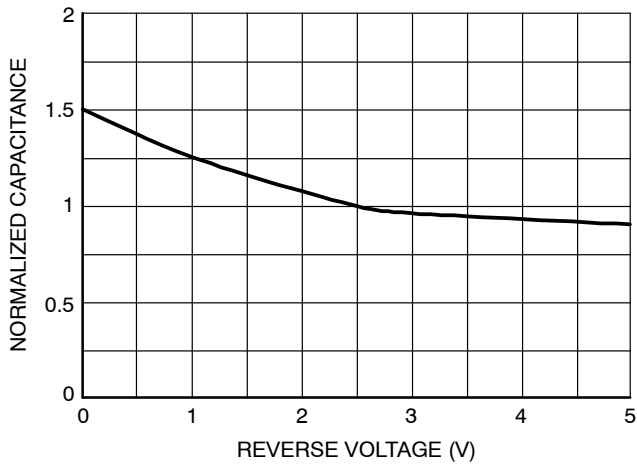

Figure 3. Typical Capacitance vs. Reverse Biased Voltage (Normalized Capacitance, Cd @ 2.5 V)

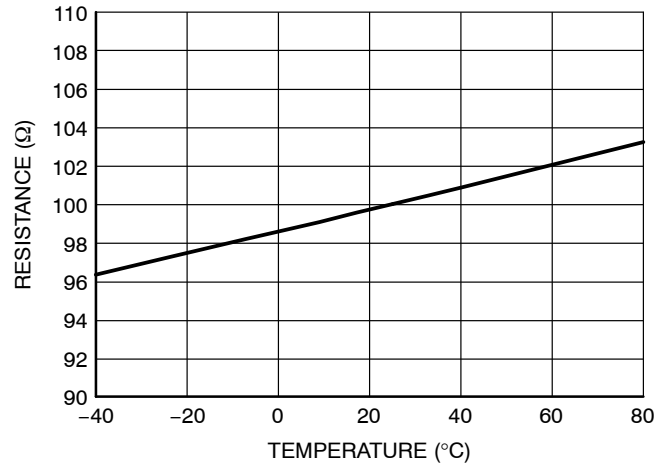

Figure 4. Typical Resistance over Temperature

NUF6406MN

PACKAGE DIMENSIONS

DFN12 3.0x1.35, 0.5P

CASE 506AD-01

ISSUE J

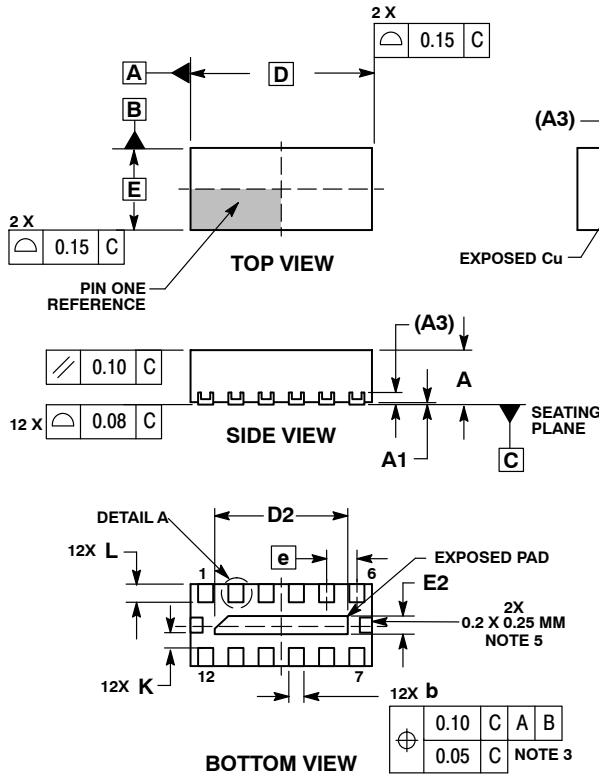

NOTES:

1. DIMENSIONING AND TOLERANCING PER ASME Y14.5M, 1994.
2. CONTROLLING DIMENSION: MILLIMETER.
3. DIMENSION b APPLIES TO PLATED TERMINAL AND IS MEASURED BETWEEN 0.25 AND 0.30 MM FROM TERMINAL.
4. COPLANARITY APPLIES TO THE EXPOSED PAD AS WELL AS THE TERMINALS.
5. EXPOSED PADS CONNECTED TO DIE FLAG, USED AS TEST CONTACTS.

| DIM | MILLIMETERS | |
|-----|-------------|------|
| | MIN | MAX |
| A | 0.80 | 1.00 |
| A1 | 0.00 | 0.05 |
| A3 | 0.20 REF | |
| b | 0.18 | 0.30 |
| D | 3.00 BSC | |
| D2 | 2.10 | 2.30 |
| E | 1.35 BSC | |
| E2 | 0.20 | 0.40 |
| e | 0.50 BSC | |
| K | 0.20 | --- |
| L | 0.20 | 0.40 |
| L1 | 0.00 | 0.15 |

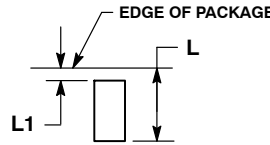

SOLDERING FOOTPRINT*

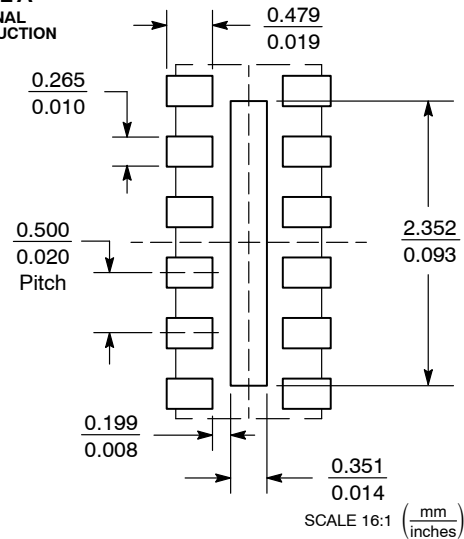

*For additional information on our Pb-Free strategy and soldering details, please download the ON Semiconductor Soldering and Mounting Techniques Reference Manual, SOLDERRM/D.

ON Semiconductor and are registered trademarks of Semiconductor Components Industries, LLC (SCILLC). SCILLC reserves the right to make changes without further notice to any products herein. SCILLC makes no warranty, representation or guarantee regarding the suitability of its products for any particular purpose, nor does SCILLC assume any liability arising out of the application or use of any product or circuit, and specifically disclaims any and all liability, including without limitation special, consequential or incidental damages. "Typical" parameters which may be provided in SCILLC data sheets and/or specifications can and do vary in different applications and actual performance may vary over time. All operating parameters, including "Typicals" must be validated for each customer application by customer's technical experts. SCILLC does not convey any license under its patent rights nor the rights of others. SCILLC products are not designed, intended, or authorized for use as components in systems intended for surgical implant into the body, or other applications intended to support or sustain life, or for any other application in which the failure of the SCILLC product could create a situation where personal injury or death may occur. Should Buyer purchase or use SCILLC products for any such unintended or unauthorized application, Buyer shall indemnify and hold SCILLC and its officers, employees, subsidiaries, affiliates, and distributors harmless against all claims, costs, damages, and expenses, and reasonable attorney fees arising out of, directly or indirectly, any claim of personal injury or death associated with such unintended or unauthorized use, even if such claim alleges that SCILLC was negligent regarding the design or manufacture of the part. SCILLC is an Equal Opportunity/Affirmative Action Employer. This literature is subject to all applicable copyright laws and is not for resale in any manner.

PUBLICATION ORDERING INFORMATION

LITERATURE FULFILLMENT:
 Literature Distribution Center for ON Semiconductor
 P.O. Box 5163, Denver, Colorado 80217 USA
Phone: 303-675-2175 or 800-344-3860 Toll Free USA/Canada
Fax: 303-675-2176 or 800-344-3867 Toll Free USA/Canada
Email: orderlit@onsemi.com

N. American Technical Support: 800-282-9855 Toll Free USA/Canada
Europe, Middle East and Africa Technical Support:
 Phone: 421 33 790 2910
Japan Customer Focus Center
 Phone: 81-3-5773-3850

ON Semiconductor Website: www.onsemi.com
Order Literature: <http://www.onsemi.com/orderlit>

For additional information, please contact your local Sales Representative